

KUBIC

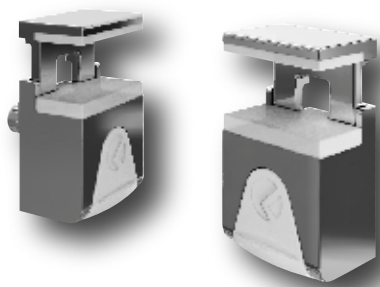

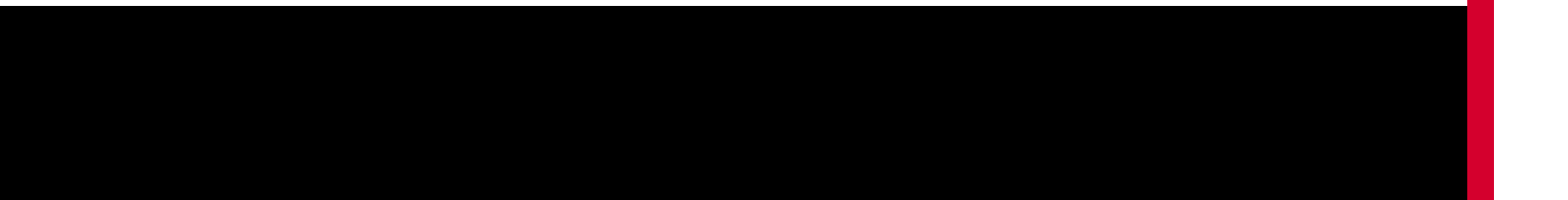

**KUBIC** is the new locking glass shelf support, freshly designed to match the contemporary aesthetic trends of the market. Conceived to guarantee furniture transportation with glass shelves already assembled. Locking and unlocking of the glass shelf can be carried out manually without any tool. Glass is blocked on both upper and lower side by soft rubber elements, in accordance with the actual function and safety norms. It is suitable for glass shelves 4-8 mm thick.

It is available in 4 different versions:

- Ø 3mm pin
- Ø 5mm pin
- screw hole for 3.5x16mm countersunk wood screw
- screw hole for M4x16mm countersunk screw

Zinc Alloy, Engineering Plastic.

In accordance with the regulation UNI EN 14749/05

PAT. PENDING

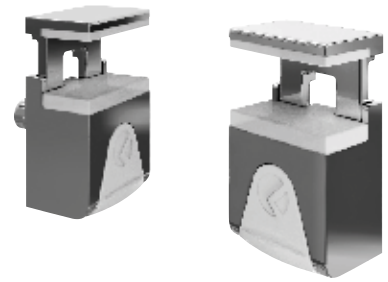

**ASSEMBLING**

**1**

INSTALLATION INTO THE CABINET

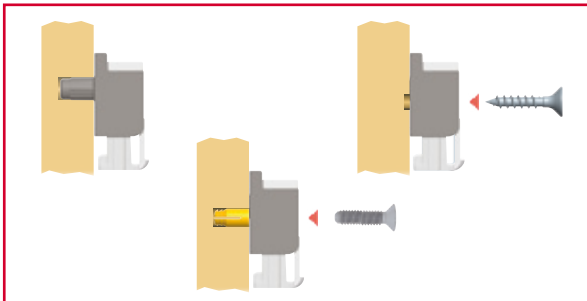

**2**

INSERT THE GLASS SHELF HORIZONTALLY INTO THE CABINET (ALSO WITH DOOR ALREADY ASSEMBLED).

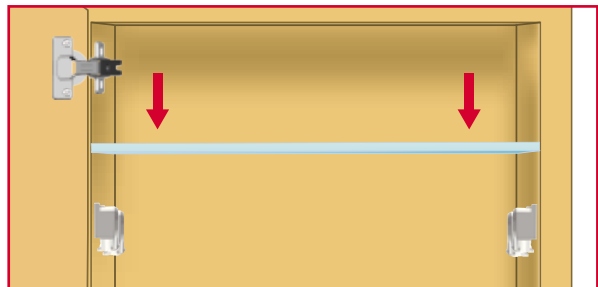

**3**

PUSH DOWN THE UPPER BRACKET INTO THE MAIN BODY UNTIL IT PERFECTLY FITS THE GLASS THICKNESS

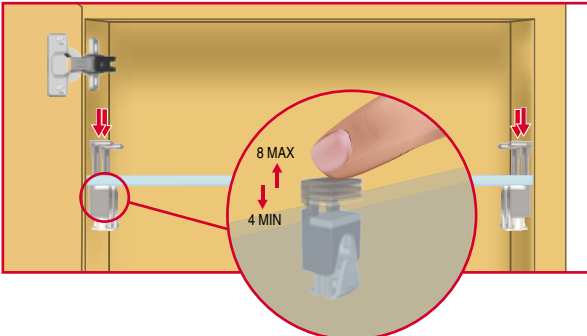

**4**

SECURE THE GLASS IN POSITION BY PRESSING UPWARDS THE PLASTIC LOCKING CLIP.

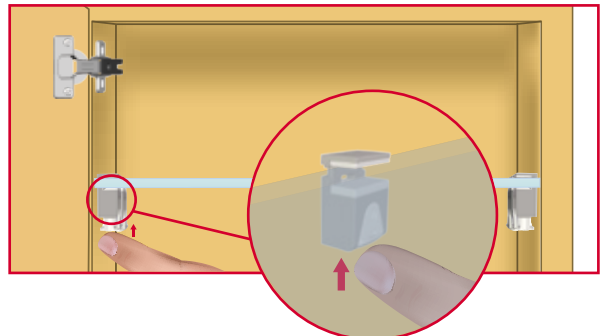

**SHELF ASSEMBLING AND REPOSITIONING**

**SHELF REMOVAL**  
PRESSING DOWNWARDS THE PLASTIC LOCKING CLIP AND EASE THE SHELF OUT

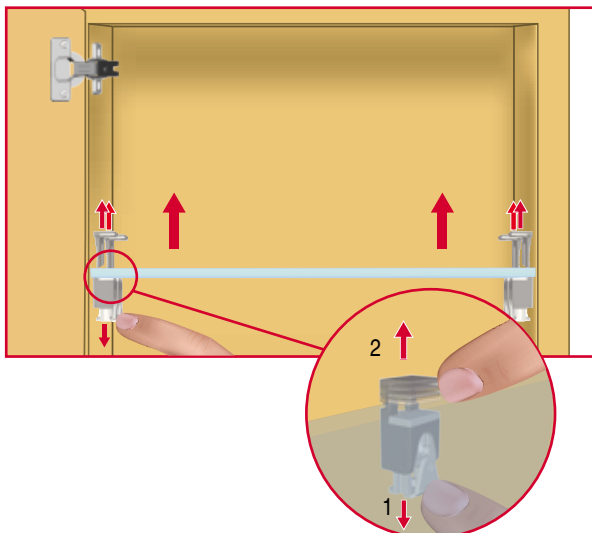

**SHELF REPOSITIONING**  
TO REPOSITION THE SHELF REPEAT OPERATIONS AS SHOWN IN PCS. 2-3-4.

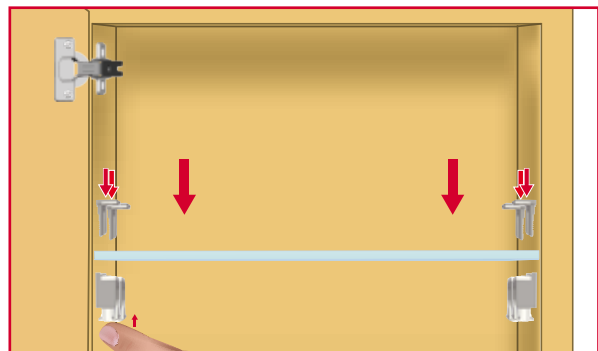

## KUBIC UPPER BRACKET

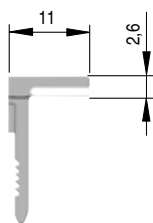

With engineering plastic rubber.  
For glass shelves 4 to 8mm thick.  
Zinc alloy  
Engineering plastic rubber

Part. no	Rubber	Finish
16019140YA	Natural	Nickel-plated

Other finishes available on request

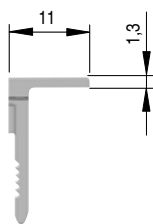

With engineering plastic rubber.  
For glass shelves 5 to 9mm thick.  
Zinc alloy

Part. no	Finish
16019130YA	Nickel-plated

Other finishes available on request

## KUBIC MAIN BODY

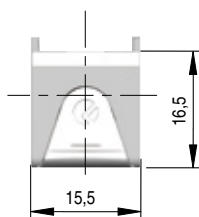
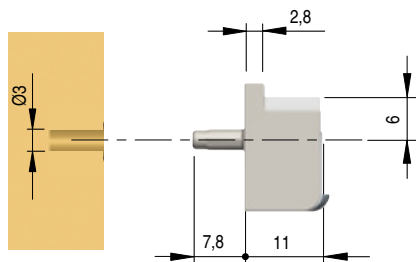

With Ø 3mm pin  
Zinc alloy  
Engineering plastic rubber

Part. no	Rubber	Locking clip	Finish
16019011YA	Natural	White	Nickel-plated
16019010YA	Natural	Grey	Nickel-plated

Other finishes available on request

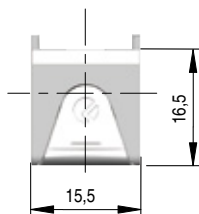
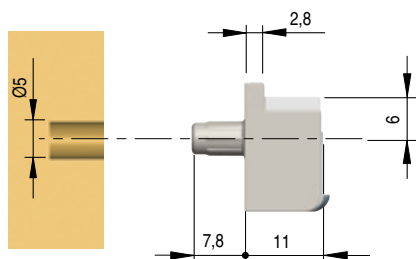

With Ø 5mm pin  
Zinc alloy  
Engineering plastic rubber

Part. no	Rubber	Locking clip	Finish
16019021YA	Natural	White	Nickel-plated
16019020YA	Natural	Grey	Nickel-plated

Other finishes available on request

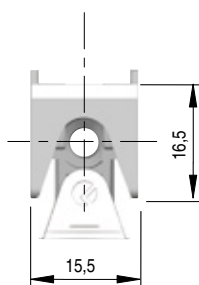
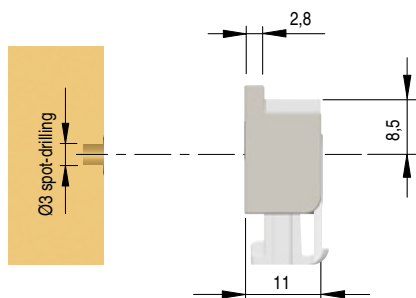

With hole for countersunk head wood screw Ø 3,5x16mm  
and M4 spreading dowel.  
Zinc alloy  
Engineering plastic rubber

Part. no	Rubber	Locking clip	Finish
16019031YA	Natural	White	Nickel-plated
16019030YA	Natural	Grey	Nickel-plated

Other finishes available on request



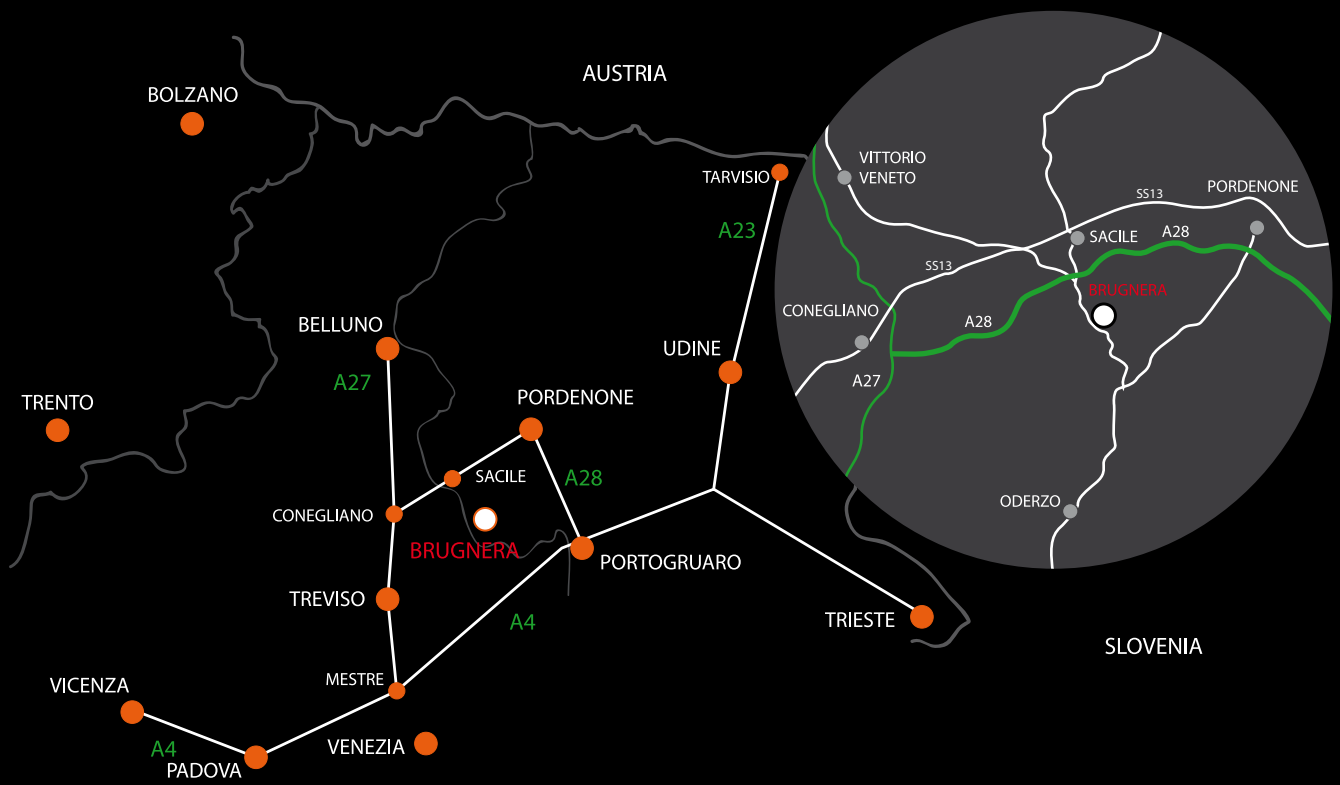

ITALIANA FERRAMENTA

Via Taglio n° 87 I - 33070 Maron di Brugnera (PN) Tel. +39 0434 428211 Fax +39 0434 428242 [www.italianaferramenta.com](http://www.italianaferramenta.com) [info@italianaferramenta.it](mailto:info@italianaferramenta.it)